



VBH Deutschland GmbH, Büro: Hagener Strasse 52, 59846 Sundern

Office  
Kornthal-Münchingen

Windowood  
Oktyabrskaya 18

222521

Written by Rainer Benz	Organisation by Norbert Appelhans	e-Mail ce-fix@vbh.de	Telephone 00491718602438	Telefax 0499406 283764	Date 08.10.2019
---------------------------	--------------------------------------	-------------------------	-----------------------------	---------------------------	--------------------

## CE Documents

Dear Sir / Madame,

Thank you for your decision. We are pleased to present you with your CE product pass along with further explanations in the following pages (Annex 2 and 3). The product pass corresponds to an ITT report (initial test report) according to EN 14351-1.

Annex 1 contains the component sheets that you selected when entering your construction. The components sheets serve as a technical and structural description of your window system and are a constituent of the VBH product pass. You will also find relevant information regarding processing and internal production controlling on the component sheets.

In Annexes 2 and 3, the performance characteristics of the product standard are explained and details are provided. The classifications of the characteristics are provided and the transfer rules are formulated therein.

With your **user name** and your **password**, you receive the authorisation to use the comprehensive CE service areas on the internet at [www.ce-fix.eu](http://www.ce-fix.eu). Here, you will find comprehensive CE documents for your daily activities, including IPC (internal production controlling), operation, maintenance and servicing, and our expert area (such as thermal insulation, noise protection and wind load zones).

Please contact your VBH team if you have any questions about the CE mark.

We wish you continued success.

Your VBH Deutschland GmbH

per pro Norbert Appelhans  
- CE Officer-

# ift Product Passport External Pedestrian Doorset in escape routes as per EN 14351-1



No. 200 36164-3 / RTFT-78-DF-1DE-MD-PF2-N-AS-K-2

valid until 15 January 2022

Client is system supplier **VBH Holding GmbH**  
Siemensstraße 38  
D-70825 Korntal-Münchingen

System	<b>VBH 78 HT R</b>
Product family	escape door, single leaf, opening outwards, with/without fanlight, with/without side panels
System boundaries	941 mm width of leaf rebate 2120 mm height of leaf rebate subject to compliance with the maximum permitted leaf weight Locking state: engaged in latch
Frame material	<b>Timber</b> average density: 0,37 g/cm <sup>3</sup> - 0,57 g/cm <sup>3</sup>
Floor connection	<b>threshold, with water bar</b>
Glazing	<b>structure 4/16/4, 4/18/4, 5/16/5</b> $U_g = 1,1 \text{ W/m}^2\text{K}$ <b>thermally improved edge spacer</b>

## Basis

EN 14351-1:2006 + A2:2016  
Windows and external pedestrian doorsets

ift Certification Scheme for windows and external pedestrian doorsets (QM320)

Certification and surveillance contract No. 181 SG 8030058

## Instructions for use

The ift Product Passport can be used as type test (TT) report.

The ift Product Passport provides evidence of the general performance of the designated product family as set out by the product standard.

The extrapolation rules of the type test as per EN 14351-1 Annex E apply.

Use of the performance characteristics is subject to the national statutory regulations of the building supervisory authorities as well as the contractual provisions.

As set out by the product standard the manufacturer is responsible for ensuring conformity to the declared characteristics. For this purpose the manufacturer is obliged to set up adequate factory production control. Durability of the door system shall be ensured by using adequate state-of-the-art material and finishes that last for the agreed service life of the product.

The cover sheet can be used as abstract.

The ift Product Passport is also the basis for ift product certification.

Characteristics	Resistance to wind load	Resistance to snow and permanent load <sup>1)</sup>	Fire characteristics <sup>1)</sup>	Watertightness <sup>4)</sup>	Dangerous substances <sup>2)</sup>	Impact resistance	Load-bearing capacity of safety devices
Class / Value	C2	Not applicable	Not applicable	0	Country-specific	1	Not applicable
Characteristics	Height and width <sup>3)</sup>	Ability to release	Acoustic performance	Thermal transmittance	Radiation properties	Air permeability	Operating forces
Class / Value	Order specifications	Requirement fulfilled	npd	$U_{10} = 1,3 \text{ W/m}^2\text{K}$	CE mark glazing	2	2
Characteristics	Mechanical strength	Ventilation	Bullet resistance	Explosion resistance	Resistance to repeated opening and closing	Behaviour between different climates	Burglar resistance
Class / Value	3	npd	npd	npd	5	2 (c)	npd

1) does not apply to external pedestrian doorsets  
2) evidence as set out by country of destination

3) clear opening dimensions as specified by manufacturer  
4) without waterbar - class 0

## ift Rosenheim

15 January 2019

Christian Kehrner, Dipl.-Ing. (FH)  
Head of Certification and Surveillance Body

Robert Krippahl, Dipl.-Ing. (FH)  
Assistant Head  
Building Components

Pascal Geiger, Dipl.-Ing. (FH)  
Product Engineer  
Building Components

## Notes on publication

The "Conditions and Guidance on the Use of ift Test Documents" apply.

## Contents

The ift Product Passport comprises:  
Annex 1: Component sheets  
Annex 2: Performance characteristics as per EN 14351-1  
Annex 3: Extrapolation rules as per EN 14351-1 Annex E

Annex 1

Component sheet for ift product passport external pedestrian doorsets as per EN 14351-1

Product passport

200 36164-3 / RTFT-78-DF-1DE-MD-PF2-N-AS-K-2

Page 2

Date 15.01.2019

Client VBH Holding GmbH, D-70825 Korntal



**Type of opening**

**Types of opening covered by evidence of performance/report**

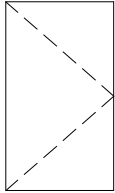

Side-hung door right/left  
opening outwards

**Sample combinations**

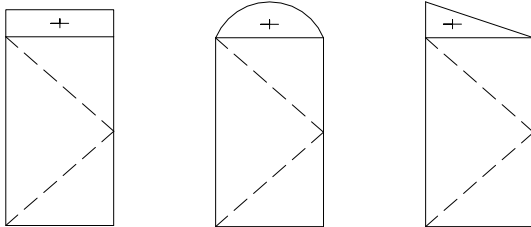

Side-hung door right/left  
opening outwards  
with fixed fanlight

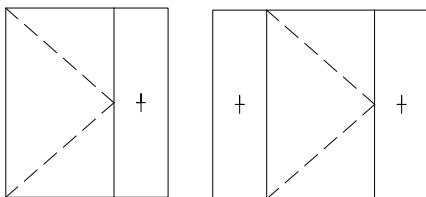

Side-hung door right/left  
opening outwards  
with fixed side part(s)

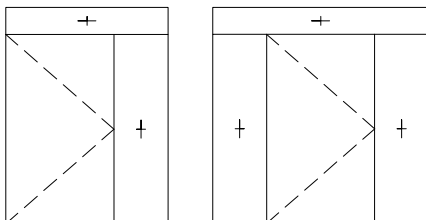

Side-hung door right/left  
opening outwards  
with fixed side panel/s  
with fanlight

**Special shapes**

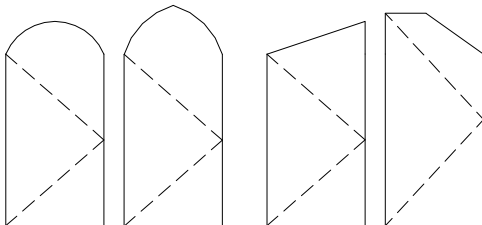

Arched/basket-handle arched  
Segmental arch  
Pitched  
Observe maximum locking distance.

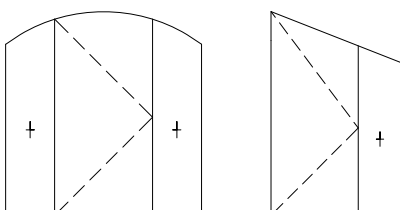

Special shapes with side panel/s  
Observe maximum locking distance.

## System

### Presentation and structure

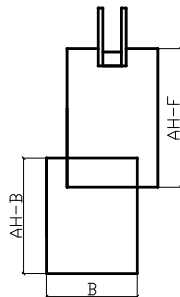

<b>Designation</b>	framed door 78
<b>Face height casement member (AH-F)</b>	140 mm (minimum dimensions)
<b>Face height frame member (AH-B)</b>	80 mm (minimum dimensions)
<b>Face height transom</b>	140 mm (minimum dimensions)
<b>Profile width (B)</b>	78 to 82 mm

### Notes on relevant rules and regulations

<b>Timber species</b>	- VFF Guidance Sheet HO.06 (2004-07) "Wood species for window joinery -Properties, table of wood species"
<b>Timber quality</b>	- EN 942 (2007-06) "Timber in joinery – General requirements" - VFF Guidance Sheet HO.02 (2003-02) "Selection of the wood quality for wood windows and external pedestrian doorsets" - pr EN 14220 (2006) "Timber and wood-based materials in external windows, external door leaves and external door frames - Requirements and specifications"
<b>Coatings of timber doors</b>	- VFF Guidance Sheet HO.01 (2001-09) "Classification of coatings on wood windows and external pedestrian doorsets" - VFF Guidance Sheet HO.03 (2004-04) "Requirements for coating systems for factory coating of wood windows and external pedestrian wood doorsets" - VFF Guidance Sheet HO.05 (2000-09) "Guideline for visual inspection of finished surfaces of wood windows and casement doors"

### Factory production control (FPC)

<b>Organisation and personnel</b>	- The manufacturer shall establish, document, and maintain factory production control system adapted to the specific system. A person trained and responsible for factory production control shall be appointed in each manufacturing unit.
<b>Equipment</b>	- Calibrate and inspect regularly all weighing, measuring and testing equipment. Inspect and maintain regularly all equipment used in the manufacturing process.
<b>Raw materials and components</b>	- During the control of incoming goods, check conformity of all incoming raw material and components.
<b>Production process, testing and evaluation of the product</b>	- Manufacturer shall establish documented test methods to ensure conformity with the specified performance characteristics. The non-finished products and the finished products shall be inspected on the basis of a fixed test plan
<b>Recording of results</b>	- All results obtained from inspection/testing during factory production shall be recorded. All actions to be taken in the case of non-conformity shall be recorded. For traceability, establish and ensure clear marking of the products.
<b>Storage of records</b>	- The documents referring to factory production control shall be retained for the period specified by the manufacturer, in most cases for the time of validity of the reports/evidence of performance.

## Timber species

### List of timber species and apparent densities

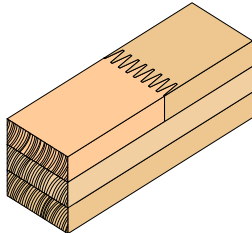

<b>Mean density</b>	from 0.37 g/cm <sup>3</sup> to 0.57 g/cm <sup>3</sup>
<b>Moisture content</b>	12% ± 3%

<b>Timber species</b>	<b>Botanical name</b>	<b>Mean density</b>
Fir	Abies alba	0.45 g/cm <sup>3</sup>
Spruce	Picea abies	0.46 g/cm <sup>3</sup>
Pine	Pinus sylvestris	0.52 g/cm <sup>3</sup>
Douglas fir, Oregon Pine	Pseudotsuga menziesii	0.52 g/cm <sup>3</sup>
Cedar (Western Red Cedar)	Thuja plicata	0.37 g/cm <sup>3</sup>
Hemlock (Western Hemlock)	Tsuga heterophylla	0.47 g/cm <sup>3</sup>
Meranti (Red Seraya, Red Meranti)	Shorea spp.	0.45 g/cm <sup>3</sup>
Larch	Larix spp.	0.57 g/cm <sup>3</sup>
Mahogany	Swietenia macrophylla	0.55 g/cm <sup>3</sup>
Khaya	Khaya spp.	0.54 g/cm <sup>3</sup>
Gerutu (Light White Seraya)	Parashorea spp.	0.53 g/cm <sup>3</sup>
Framire	Terminalia ivorensis	0.53 g/cm <sup>3</sup>

### Notes on relevant rules and regulations

#### **Rules and regulations**

- HO.06-1 VFF Merkblatt „Holzarten für den Fensterbau – Teil1: Eigenschaften, Holzartentabelle“ (VFF Guidance Sheet "Wood species for window joinery – Part 1: Properties, table of wood species)

### General information on factory production control (FPC)

#### **Material control/control of incoming goods**

- Determine density and moisture content by sampling and record.
- The timber qualities shall be in conformity with the agreed terms of delivery.

## Frame corner joint

### Presentation and structure

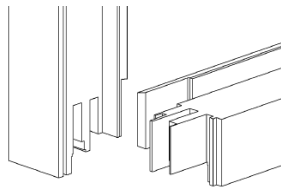

<b>Joint</b>	mortise and tenon joint
<b>Design</b>	two and a half
<b>Use</b>	frame member casement member transom

### Notes on relevant rules and regulations

#### **Design / method and details**

Based on:

- DIN 68121-1 (1993-09) "Timber profiles for windows and casement doors: Dimensions, quality requirements"
- DIN 68121-2 (1990-06) "Timber profiles for windows and casement doors: General principles"
- Select suitable material for frame corner joints and ensure due processing in terms of functionality, permanent tightness and serviceability for an adequate period of time. They shall not have a negative effect on dimensional stability.

#### **Gluing**

- DIN EN 204 (2001-09) "Classification of thermoplastic wood adhesives for non-structural applications"
- ift Guideline(1998-04) "Bonding of timber windows – Part 2"
- The adhesive must be spread over the entire surface of the areas to be glued..
- The adhesive must protrude from all joints when pressing the parts together.
- Thickness of the gluelines shall not be greater than 0.1mm after gluing.

#### **Requirements**

- ift Guideline FE-08-1 (2007-07) "Frame corner joints of timber windows: Requirements, test and assessment"
- DIN 18355 (2005-01) "VOB German Construction Contract Procedures – Part C: General Technical Specifications for Building Works (ATV) – Joinery Works"

### Factory production control (FPC)

#### **Design/ method and details**

- The frame corner joints must be flush. Offset between vertical and horizontal timber members shall be  $\leq 0.2$  mm.
- Check for uninterrupted and accurate fit of joint

#### **Gluing of frame corner joint**

- Check conformity of glue mixture, gluespread, press time, and curing time with manufacturer's specifications; check glue quality after pressing (glue squeeze-out , visual inspection).
- Adjust room climate to the gluing conditions.
- Check by visual inspection all adhesive surfaces and gluelines for completeness of gluespread and all gluelines/joints for glue squeeze-out. .

## Sealing system

### Presentation and structure

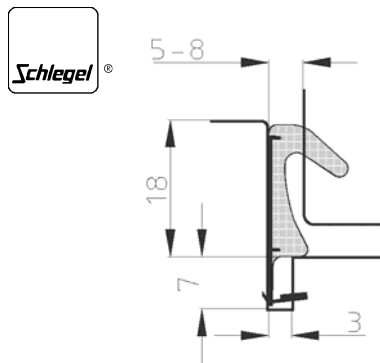

<b>Manufacturer</b>	Schlegel Germany GmbH
<b>Type</b>	QL 3109
<b>Material</b>	PU foam
<b>Corner design</b>	notched
<b>Use</b>	casement seal/frame seal
<b>Classification as per EN 12365</b>	W 44244
<b>ift product certification</b>	 QM 338 Gaskets and weatherstripping No. 593 7017744

### Notes on processing

#### Observe manufacturer's processing instructions and product documentation

##### Installation of gaskets/weatherstripping

- Introduce gaskets without residual stress and dimensionally oversized
- Ensure accurate fit of gasket.
- The sealing joints shall be without any gaps.

##### Corner design\*

- \* Ensure tightness and accurate fit of corner details
- \* Remove burr from welded seals/gaskets.
- \* Do not cut through the notches of notched gaskets
- \* Process corner moulds according to manufacturer's instructions.
- \* Adapt vulcanised gaskets to frame size.
- \* Draw perimeter gaskets around corners without residual stress.
- \* Observe manufacturer's recommendations for the faceplate area.

\* For corner details observe manufacturer's processing instructions and those for the intended use.

### Factory production control.

##### Material control/ control of incoming goods

- Check
- shipping documents of incoming goods for conformity with the order specifications
  - incoming goods for due condition when delivered .

##### Production control

- Continuous control and inspection of gaskets for
- correct installation and accurate fit.
  - correctness of corner details according to manufacturer's specifications.
  - continuity of sealing plane around perimeter and gap-free joints

##### Control of finished product

- Check
- functionality of finished product.
  - operability

##### Storage

- Store seals/gaskets I
- at a dry, clean place protected from weather, at normal temperature in a production hall

## Floor threshold

### Presentation and structure

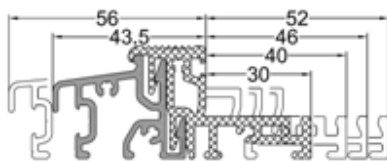

Weser 74+84+90+95 / 32-TI  
Weser 86+96+102+108 / 32-TI

<b>Manufacturer</b>	Hermann Gutmann Werke AG
<b>Type</b>	Weser 74+84+90+95 / 32 -TI Weser 86+96+102+108 / 32 -TI
<b>Design</b>	thermal break
<b>Threshold height</b>	32 mm
<b>Threshold depth</b>	74 / 84 / 90 / 95 mm 86 / 96 / 102 / 108 mm
<b>Details of side connection</b>	filling sealant or coping, with seal
<b>Fixing method</b>	screw-fastened
<b>Use</b>	for external pedestrian doorsets
<b>ift product certification</b>	 QM 340 weather boards and floor thresholds No. 598 6026301

### Notes on processing

Observe manufacturer's processing instructions and product documentation. .

- |                        |  |
|------------------------|--|
| <b>Cutting to size</b> | - Refer to manufacturer's specifications for dimensions for cutting to size  |
| <b>Installation*</b>   | <ul style="list-style-type: none"> <li>- * Using a moulded part, join frame member and threshold by mechanical means, ensuring accurate fit.</li> <li>- * Using a counter profile, join frame member and threshold by mechanical means, ensuring accurate fit.</li> <li>- * Seal side joints to frame member using gunned sealant</li> </ul> |

\* Install product according to manufacturer's processing instructions.

### Factory production control



- |   |   |
|---|---|
| <b>Material control/control of incoming goods</b> | Check <ul style="list-style-type: none"> <li>- shipping documents of the incoming goods for conformity with the order specifications.</li> <li>- incoming goods for due condition when delivered</li> </ul>                             |
| <b>Production control</b>                         | Continuous control and inspection for <ul style="list-style-type: none"> <li>- correct installation and accurate fit</li> <li>- correct sealing of connecting joints</li> <li>- continuity of perimeter rebate plane of seal</li> </ul> |
| <b>Control of finished product</b>                | Check <ul style="list-style-type: none"> <li>- weather board for functionality of finished product</li> <li>- for operability</li> </ul>  |
| <b>Storage</b>                                    | Store weather boards at <ul style="list-style-type: none"> <li>- dry, clean place, protected from weather.</li> </ul>   |

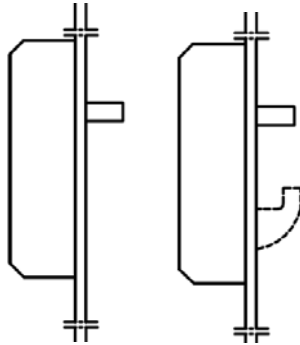

## Emergency exit device - set

### Device as per EN 179 - Presentation and structure



<b>Distributor</b>	VBH Holding AG
<b>Manufacturer</b>	KFV Karl Fliether GmbH & Co. KG
<b>Type</b>	KFV EP930 KFV EP960
<b>Locking mechanism</b>	multi-point locking mechanism with escape door function
<b>Operation</b>	key operation
<b>Dimensions</b>	Backset 35 - 80 mm Flat faceplate min. 16 mm U faceplate of min. 20 mm
<b>Fixing method</b>	with screws of min. 4,5 x 40 mm
<b>Evidence</b>	 EC certificate of conformity No.: 0432-CPD-00900
<b>ift product certification</b>	 No.: 7034662 QM 342 No.: 230 7060937

### Notes on relevant rules and regulations

#### Observe manufacturer's product documentation and specifications.

##### Fixing method

- When screwing into place, observe specifications of manufacturer for screw-in angle, screw position, screw-in torque, drillings, routing details and screw patterns. Always adapt fasteners to the existing countersinking, that is, the screw head shall not protrude from the faceplate once screwed into place.

##### Corrosion protection

- Protective measures during the construction phase and compliance with and application of maintenance recommendations.

### Factory production control.

##### Material control/control of incoming goods

- Upon receipt, the goods shall be checked for obvious defects by visual inspection.
- The shipping documents of the incoming goods shall be checked for conformity with the order specifications.

##### Production control

- Ensure accurate fit of installed lock and/or multi-point lock based on DIN 18251-1 to 3.
- The recesses to accommodate the lock shall be free of any chips/splinters before installing the locks and/or multipoint locks. Do not cut through to the glazing rebate platform.
- Ensure suitability of fasteners used and completeness of screw connections.
- Once installed, do not drill in the area of the lock recess.

##### Control of finished product

- Check the lock and/or the multi-point lock for functionality. For this test, the lock and/or multipoint lock shall be in the fully locked position. The bolts shall engage smoothly and without restriction in the strike plates
- Check operating torque of door handle and key.

Annex 1

Component sheet for ift product passport external pedestrian doorsets as per EN 14351-1

Product passport

200 36164-3 / RTFT-78-DF-1DE-MD-PF2-N-AS-K-2

Page 9

Date 15.01.2019

Client VBH Holding GmbH, D-70825 Korntal



**Locking combinations as per EN 179 - Representation and design – single leaf**



<b>Distributor</b>	VBH Holding AG
<b>Manufacturer</b>	KFV Karl Fliether GmbH & Co. KG
<b>Locking mechanism</b>	KFV EP930 KFV EP960
<b>Function</b>	Transmission/key function E Changeover function B
<b>Category</b>	 EC certificate of conformity No.: 0432-CPD-00900

**Locking combinations as per EN 179 - Representation and design – double leaf**



<b>Distributor</b>	VBH Holding AG
<b>Manufacturer</b>	KFV Karl Fliether GmbH & Co. KG
<b>Locking mechanism</b>	KFV EP930 KFV EP960
<b>Function</b>	Transmission/key function E Changeover function B
<b>Category</b>	 EC certificate of conformity No.: 0432-CPD-00900

Annex 1

Component sheet for ift product passport external pedestrian doorsets as per EN 14351-1

Product passport

200 36164-3 / RTFT-78-DF-1DE-MD-PF2-N-AS-K-2

Page 10

Date 15.01.2019

Client VBH Holding GmbH, D-70825 Korntal



**Combinable door handles as per EN 179 - Presentation and structure**

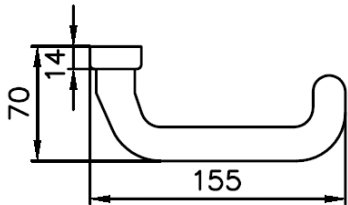

**Distributor**

VBH Holding AG

**Manufacturer**

FSB Franz Schneider Brakel GmbH + Co

**Type**

Door handle FSB 06-1146 79 RTV RO

**Category**



EC certificate of conformity  
No.: 0432-CPD-0090

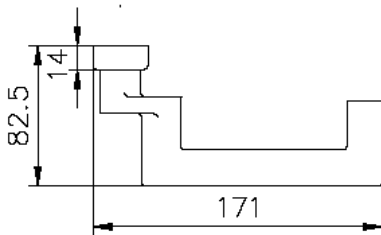

**Distributor**

VBH Holding AG

**Manufacturer**

FSB Franz Schneider Brakel GmbH + Co

**Type**

Door handle FSB 06-1016 76 RTV RO

**Category**



EC certificate of conformity  
No.: 0432-CPD-0090

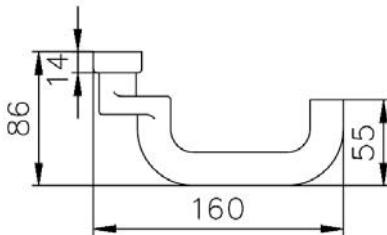

**Distributor**

VBH Holding AG

**Manufacturer**

FSB Franz Schneider Brakel GmbH + Co

**Type**

Door handle FSB 06-1070 79 RTV RO

**Category**



EC certificate of conformity  
No.: 0432-CPD-0090

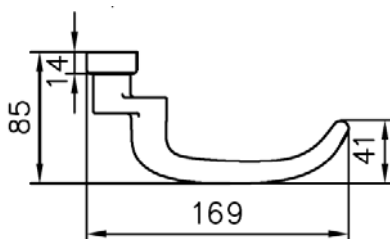

**Distributor**

VBH Holding AG

**Manufacturer**

FSB Franz Schneider Brakel GmbH + Co

**Type**

Door handle FSB 06-1023 79 RTV RO

**Category**



EC certificate of conformity  
No.: 0432-CPD-0090

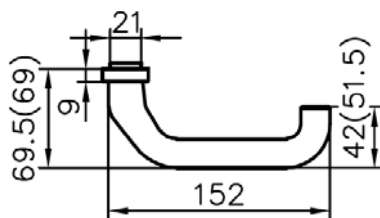

**Distributor**

VBH Holding AG

**Manufacturer**

DORMA GmbH & Co. KG

**Type**

Door handle Dorma Premium 8100VFS/6621

**Category**



EC certificate of conformity  
No.: 0432-CPD-0090

Annex 1

Component sheet for ift product passport external pedestrian doorsets as per EN 14351-1

Product passport

200 36164-3 / RTFT-78-DF-1DE-MD-PF2-N-AS-K-2

Page 11

Date 15.01.2019

Client VBH Holding GmbH, D-70825 Korntal

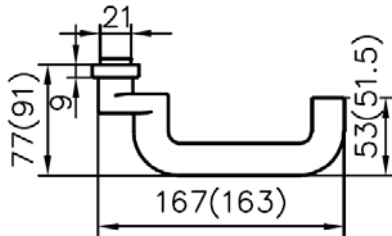

**Distributor**

VBH Holding AG

**Manufacturer**

DORMA GmbH & Co. KG

**Type**

Door handle Dorma Premium 8100AFS/6621

**Category**



EC certificate of conformity  
No.: 0432-CPD-0090

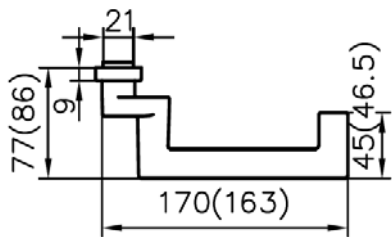

**Distributor**

VBH Holding AG

**Manufacturer**

DORMA GmbH & Co. KG

**Type**

Door handle Dorma Premium 8907AFS/6621

**Category**



EC certificate of conformity  
No.: 0432-CPD-0090

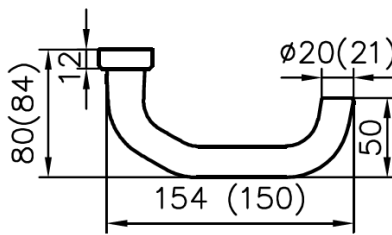

**Distributor**

VBH Holding AG

**Manufacturer**

HOPPE Holding AG

**Type**

Door handle HOPPE, Modell Paris

**Category**



EC certificate of conformity  
No.: 0432-CPD-0090

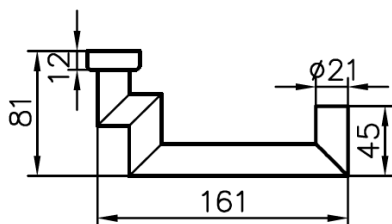

**Distributor**

VBH Holding AG

**Manufacturer**

HOPPE Holding AG

**Type**

Door handle HOPPE, Modell Rotterdam

**Category**



EC certificate of conformity  
No.: 0432-CPD-0090

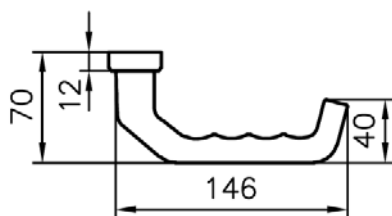

**Distributor**

VBH Holding AG

**Manufacturer**

HOPPE Holding AG

**Type**

Door handle HOPPE, Modell Liverpool

**Category**



EC certificate of conformity  
No.: 0432-CPD-0090

Annex 1

Component sheet for ift product passport external pedestrian doorsets as per EN 14351-1

Product passport

200 36164-3 / RTFT-78-DF-1DE-MD-PF2-N-AS-K-2

Page 12

Date 15.01.2019

Client VBH Holding GmbH, D-70825 Korntal

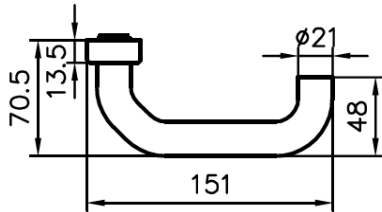

**Distributor**

VBH Holding AG

**Manufacturer**

ECO Schulte GmbH & Co. KG

**Type**

Door handle esco, Modell R 202 VFS

**Category**



EC certificate of conformity  
No.: 0432-CPD-0090

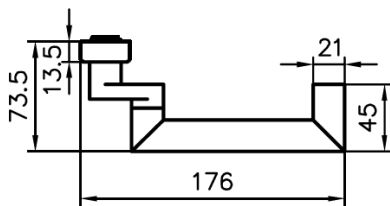

**Distributor**

VBH Holding AG

**Manufacturer**

ECO Schulte GmbH & Co. KG

**Type**

Door handle esco, Modell E 104 AFS

**Category**



EC certificate of conformity  
No.: 0432-CPD-0090

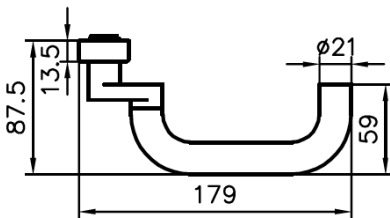

**Distributor**

VBH Holding AG

**Manufacturer**

ECO Schulte GmbH & Co. KG

**Type**

Door handle esco, Modell R 201 AFS

**Category**



EC certificate of conformity  
No.: 0432-CPD-0090

**Combinable door handles**

Use of alternative door handle models is generally possible under one's own responsibility, but is subject to a separate test. When using door handle models not specified in this certificate, conformity with the requirements set out by DIN EN 179 : 2008-04 must be ensured.

## Hinges

### Presentation and structure



<b>Manufacturer</b>	SIMONSWERK GmbH
<b>Type</b>	BAKA Protect Serie 4000
<b>Number</b>	3 pieces
<b>Scope</b>	rebated timber doors
<b>Load value as per EN 1935:2002</b>	60 kg at 200,000 cycles
<b>Fixing method</b>	milled into casement member observing accurate fit and screwed into place using 5 screws of at least 5 mm x 40 mm milled into frame member observing accurate fit and locked in place using enclosed fastening pins
<b>ift product certification</b>	 QM 343 No. 229B 7012742

### Notes on relevant rules and regulations

#### Observe manufacturer's product documentation and specifications.

<b>Hinges</b>	- EN 1935 Building hardware – Single-axis hinges - Requirements and test methods
<b>Fixing method</b>	- When screwing into place, observe specifications of hinge manufacturer for screw-in angle, screw position, screw-in torque, drillings, routing details, millings and screw patterns, etc. . - Observe processing instructions of hinge manufacturer, in particular, those relating to the fasteners and f and frame material used..
<b>Corrosion protection</b>	- For information on corrosion protection refer to the website and the product information
<b>Service and maintenance</b>	- For information on service and maintenance refer to the website and the product information

### Factory production control.

<b>Material control/control of incoming goods</b>	- Upon receipt, the goods shall be checked for obvious defects by visual inspection. - The shipping documents of the incoming goods shall be checked for conformity with the order specifications.
<b>Production control</b>	- Ensure conformity with the product documents provided by the hinge manufacturer (screw-in angle, screw position, drillings, routing details, milling and screw patterns, screw-in torques) . - Ensure suitability of fasteners used and completeness of the screw connections.
<b>Control of finished product</b>	- Check functionality. - Check due installation and adjustment of hinges as specified by manufacturer



## Annex 2 Declaration of performance characteristics as set out by the product standard

### 1.1 General

Depending on the intended use and the national mandatory requirements for windows and external pedestrian doorsets, an initial type test shall be conducted for verification of the characteristics listed in product standard EN 14351-1, Clause 4. As set out by the product standard, the relevant performance characteristic may be demonstrated on the basis of tests, calculation, tabulated values or by evaluation.

The side panels and/or fanlights shall be glazed in the same way as the door infill panels.

### 1.2 Resistance to wind load

(refer to EN 14351-1, Clause 4.2)

Testing of windows and external pedestrian doorsets shall be in accordance with EN 12211. Code letter C refers to the maximum permissible frontal deflection being smaller than  $l/300$ , code letter B refers to maximum permissible frontal deflection being smaller than  $l/200$  in accordance with table 2 of EN 12210. The number following the Code Letter refers to the nominal wind load of the achieved class in accordance with table 1 of EN 12210. The deflection of fixed frame members (e.g. mullions and transoms) shall be verified by calculation or testing (reference method). The results shall be expressed in accordance with EN 12210. The tests listed in EN 12210 referring to air permeability and classification shall be conducted as set out by 4.14 in accordance with EN 14351-1.

#### Classification:

Table 1 Classification of resistance to wind load for maximum deflection

Class	Deflection related to effective span width in mm
A	$l/150$
B	$l/200$
C	$l/300$

Table 2 Classification of resistance related to test pressures

Class	Positive/negative wind pressure	Alternating positive/negative load:	Safety test
1	400 Pa	200 Pa	600 Pa
2	800 Pa	400 Pa	1,200 Pa
3	1,200 Pa	600 Pa	1,800 Pa
4	1,600 Pa	800 Pa	2,400 Pa
5	2,000 Pa	1,000 Pa	3,000 Pa

### 1.3 Resistance to snow and permanent load

(refer to EN 14351-1, Clause 4.3)

The manufacturer shall provide sufficient information on the infill to enable the determination of the load-bearing capacity of the infill, e.g. information on the thickness and type of glass.

### 1.4 External fire performance

(refer to EN 14351-1, Clause 4.4)

Roof windows shall be tested and classified in accordance with EN 13501-5.

### 1.5 Watertightness

(refer to EN 14351-1, Clause 4.5)

A watertightness test shall be carried out in accordance with EN 1027. The results shall be expressed in accordance with EN 12208.

#### Classification:

Table 3 Classification of watertightness

Class	Pressure step
1A	0 Pa
2A	50 Pa
3A	100 Pa
4A	150 Pa
5A	200 Pa
6A	250 Pa
7A	300 Pa
8A	450 Pa
9A	600 Pa

### 1.6 Dangerous substances

(refer to EN 14351-1, Clause 4.6)

In so far as the state of the art permits, the manufacturer shall establish those materials in the product which are liable to emission or migration during normal intended use and for which emission or migration into the environment is potentially dangerous to hygiene, health or the environment.



### 1.7 Impact resistance

(refer to EN 14351-1, Clause 4.7)

Windows and external pedestrian doorsets fitted with glass or other fragmental material shall be tested and the results shall be expressed in accordance with EN 13049. Where relevant, the test shall be carried out from both sides.

#### Classification:

Table 4 Classification of impact resistance

Class	Drop height
1	200 mm
2	300 mm
3	450 mm
4	700 mm
5	950 mm

### 1.8 Load-bearing capacity of safety devices

(refer to EN 14351-1, Clause 4.8)

The threshold strength of 350 N shall be demonstrated by means of tests carried out as described in EN 14609 or EN 948 (reference methods), or by calculation.

### 1.9 Height and width of doorsets and French windows/casement doors

(refer to EN 14351-1, Clause 4.9)

The clear opening height and width of external pedestrian doorsets and French windows/casement doors (see EN 12519:2004, 3.1) shall be expressed in mm.

### 1.10 Ability to release

(refer to EN 14351-1, Clause 4.10)

Emergency exit devices and panic devices installed on external pedestrian doorsets in escape routes shall comply with EN 179, EN 1125, prEN 13633 or prEN 13637.

### 1.11 Acoustic performance

(refer to EN 14351-1, Clause 4.11)

The sound reduction index shall be determined in accordance with EN ISO 140-3 (reference method) or for specific window types in accordance with Annex B. The test results shall be evaluated in accordance with EN ISO 717-1.

### 1.12 Thermal transmittance

(refer to EN 14351-1, Clause 4.12)

The thermal transmittance for windows shall be determined by using:

- EN ISO 10077-1, Table F.1

The thermal transmittance for windows and external pedestrian doorsets shall be determined as follows:

by calculation using:

- EN ISO 10077-1 or
- EN ISO 10077-1 and EN ISO 10077-2

or by hot box method using:

- EN ISO 12567-1 or
- EN ISO 12567-2

### 1.13 Radiation properties

(refer to EN 14351-1, Clause 4.13)

The determination of the total solar energy transmittance (g-value) and light transmittance of translucent glazing shall be carried out in accordance with EN 410, or if relevant, with EN 13363-1 or EN 13363-2 (reference method).

### 1.14 Air permeability

(refer to EN 14351-1, Clause 4.14)

Two air permeability tests shall be carried out in accordance with EN 1026, one with positive test pressures and one with negative test pressures. The test result, defined as the numerical average of the two air permeability values ( $\text{m}^3/\text{h}$ ) at each pressure step shall be expressed in accordance with EN 12207.

#### Classification:

Table 5 Classification of air permeability

Class	Air permeability at 100 Pa per area	Air permeability at 100 Pa per joint length	Maximum test pressure
1	$50 \text{ m}^3/(\text{h}\cdot\text{m}^2)$	$12.5 \text{ m}^3/(\text{h}\cdot\text{m}^2)$	150 Pa
2	$27 \text{ m}^3/(\text{h}\cdot\text{m}^2)$	$6.75 \text{ m}^3/(\text{h}\cdot\text{m}^2)$	300 Pa
3	$9 \text{ m}^3/(\text{h}\cdot\text{m}^2)$	$2.25 \text{ m}^3/(\text{h}\cdot\text{m}^2)$	600 Pa
4	$3 \text{ m}^3/(\text{h}\cdot\text{m}^2)$	$0.75 \text{ m}^3/(\text{h}\cdot\text{m}^2)$	600 Pa

### 1.15 Durability

(refer to EN 14351-1, Clause 4.15)

The manufacturer shall provide information about maintenance and the replaceable parts.

### 1.16 Operating forces

(refer to EN 14351-1, Clause 4.16)

Manually operated windows shall be tested in accordance with EN 12046-1. The results shall be expressed in accordance with EN 13115.

#### Classification:

Table 6 Classification of operating forces

Class	Tilt and turn window (manual operation)	Sliding window
0	> 10 Nm	> 100 N
1	5 Nm to 10 Nm	30 N to 100 N
2	< 5 Nm	< 30 N

Hand operated external pedestrian doorsets shall be tested in accordance with EN 12046-2. The results shall be expressed in accordance with EN 12217.

#### Classification:

Table 7 Classification of operating forces

Class	0	1	2	3	4
Closing force (N)	-	75	50	25	10
Hand operated hardware					
- max. torque (Nm)	-	10	5	2.5	1
- max. force (N)	-	100	50	25	10
Finger operated hardware					
- max. torque (Nm)	-	5	2.5	1.5	1
- max. force (N)	-	20	10	6	4

### 1.17 Mechanical strength

(refer to EN 14351-1, Clause 4.17)

Windows shall be tested in accordance with EN 14608 and EN 14609. Prior to and after completion of those tests manually operated windows shall be tested in accordance with EN 12046-1. The results shall be expressed in accordance with EN 13115.

#### Classification:

Table 8 Classification of mechanical strength

Class	Vertical loads:	Static torsion
1	200 N	200 N
2	400 N	250 N
3	600 N	300 N
4	800 N	350 N

External pedestrian doorsets shall be tested in accordance with EN 947, EN 948, EN 949 and EN 950. The results shall be expressed in accordance with EN 1192.

#### Classification:

Table 9 Classification of mechanical strength

Class	1	2	3	4
Vertical load (N)	400	600	800	1000
Static torsion (N)	200	250	300	350
Soft and heavy body impact (J)	30	60	120	180
Hard body impact (J)	1,5	3	5	8

### 1.18 Ventilation

(refer to EN 14351-1, Clause 4.18)

Air transfer devices integrated in a window or an external pedestrian doorset shall be tested and evaluated in accordance with EN 13141-1, 4.1.

### 1.19 Bullet resistance

(refer to EN 14351-1, Clause 4.19)

After testing in accordance with EN 1523 the bullet resistant characteristics of external pedestrian doorsets shall be expressed in accordance with EN 1522.

## 1.20 Explosion resistance (refer to EN 14351-1, Clause 4.20)

### Shock tube

After testing in accordance with EN 13124-1 the explosion resistant characteristics of external pedestrian doorsets shall be expressed in accordance with EN 13123-1.

### Range test

After testing in accordance with EN 13124-2 the explosion resistant characteristics of external pedestrian doorsets shall be expressed in accordance with EN 13123-2.

## 1.21 Resistance to repeated opening and closing

(refer to EN 14351-1, Clause 4.21)

A repeated opening and closing test shall be carried out in accordance with EN 1191. The results shall be expressed in accordance with EN 12400.

### Classification:

Table 10 Classification of resistance to repeated opening and closing - Windows

Class	Number of cycles
1	5,000
2	10,000
3	20,000

Table 11 Classification of repeated opening and closing (durability) – External pedestrian doorsets

Class	Number of cycles
1	5,000
2	10,000
3	20,000
4	50,000
5	100,000
6	200,000
7	500,000
8	1,000,000

## 1.22 Behaviour between different climates

(refer to EN 14351-1, Clause 4.22)

A climate test on windows with frames manufactured from a combination of materials shall be carried out in accordance with ENV 13420.

A climate test on external pedestrian doorsets shall be carried out in accordance with EN 1121. The results shall be expressed in accordance with EN 12219. The deformations are measured in mm and shall be smaller than the permitted deformations of the relevant class. Code letter T refers to final torsion, code letter B refers to the absolute difference between final and initial torsion or bow (whichever is greater) and code letter C refers to final cup. The test climate shall be adjusted in accordance with prEN 1121 and/or prEN 1294.

### Classification:

Table 12 Classification of climatic influences – Maximum permitted deformation

Class	0	1	2	3
Torsion, T (mm)	-	8.0	4.0	2.0
Bow, B (mm)	-	8.0	4.0	2.0
Cup, C (mm)	-	4.0	2.0	1.0
Local flatness	A door leaf supplied without door frame or a door leaf forming part of a doorset or door assembly shall be in conformity with the requirements of EN 1530.			

Annex 2

Performance characteristics as per EN 14351-1

Product passport

200 36164-3 / RTFT-78-DF-1DE-MD-PF2-N-AS-K-2

Page 9 of 9

Date 15.01.2019

Client VBH Holding GmbH, D-70825 Korntal



**Required climates as per EN 1121:**

Test climate	Required climates			
	Side 1		Side 2	
	Air temperature ( $\theta_1$ ) °C	Relative humidity ( $\varphi_1$ ) %	Air temperature ( $\theta_2$ ) °C	Relative humidity ( $\varphi_2$ ) %
c	23±2	30±5	3±2	85±5
d	23±2	30±5	-15±2	No requirements
$\theta_1$	air temperature on side 1			
$\theta_2$	air temperature on side 2			
$\varphi_1$	relative humidity on side 1			
$\varphi_2$	relative humidity on side 2			
Test climate	Required climates			
	Side 1		Side 2	
	Air temperature ( $\theta_1$ ) °C	Relative humidity ( $\varphi_1$ ) %	Air temperature ( $\theta_2$ ) °C	Relative humidity ( $\varphi_2$ ) %
e	min. 20 max. 30	No requirements	Reference temperature $\theta_3 = \theta_1 + (55 \pm 5)$	No requirements
$\theta_1$	air temperature on side 1			
$\theta_2$	reference temperature for heating up the door surface by radiation The reference temperature is the average temperature of at least three reference surfaces as described in Clause 5.2 of EN 1121, placed on the surface of the door leaf or on the test frame.			
$\varphi_1$	relative humidity on side 1			
$\varphi_2$	relative humidity on side 2			



















**1.23 Burglar resistance**

(refer to EN 14351-1, Clause 4.23)

After testing in accordance with ENV 1628, ENV 1629 and ENV 1630 the results shall be expressed in accordance with ENV 1627.



















## Annex 3 Extrapolation rules as set out by Annex E in accordance with EN 14351-1

### 1.1 Extrapolation rules as set out by Annex E.1 in accordance with EN 14351-1 – window / casement door

	Characteristics	Field of direct application of characteristics (subject to similar design)
	Resistance to wind load	- 100 % of frame width and - 100 % of frame height of test specimen
	Resistance to snow load	- 100 % of test specimen overall area
	Reaction to fire	See EN 13501-1
	Watertightness	- 100 % to + 50 % of test specimen overall area
	Dangerous substances	As required by regulations
	Impact resistance	> overall area of test specimen
	Load-bearing capacity of safety devices	- 100 % of test specimen overall area
	Acoustic performance	See EN 14351-1, Annex B
	Thermal transmittance	For U-value from table: all sizes
		For U-value from calculation or measurement: Test specimen: 1.23 m x 1.48 m ≤ overall area of 2.3m <sup>2</sup>
		Test specimen: 1.48 m x 2.18 m > overall area of 2.3m <sup>2</sup>
	Radiation properties	All sizes
	Air permeability	- 100 % to + 50 % of test specimen overall area
	Operating forces	- 100 % of test specimen overall area
	Mechanical strength	- 100 % of test specimen overall area
	Ventilation	Same design and size of ventilation device
	Bullet resistance	Until relevant standards and/or guidelines are in place, undetermined conditions shall be agreed on by the manufacturer and the testing laboratory.
	Explosion resistance	Until relevant standards and/or guidelines are in place, undetermined conditions shall be agreed on by the manufacturer and the testing laboratory.
	Resistance to repeated opening and closing	- 100 % of test specimen overall area
	Behaviour between different climates	All sizes
	Burglar resistance	See ENV 1627



## 1.2 Extrapolation rules as per EN 14351-1 Annex E.2 - external pedestrian doorset

	Characteristics	Field of direct application of characteristics (providing similar design)
	Resistance to wind load	- 100 % of frame width and height of test specimen
	Watertightness	- 100 % to + 50 % of test specimen overall area
	Dangerous substances	As required by regulations
	Impact resistance	> overall area of test specimen (infill)
	Load-bearing capacity of safety devices	- 100 % of test specimen overall area
	Height and width	Declared values
	Ability to release	See EN 179, EN 1125, prEN 13633 and prEN 13637
	Acoustic performance	Weather stripping on four sides: - 100 % to + 50 % of test specimen overall area Weather stripping on three sides: - 100 % of test specimen overall area
	Thermal transmittance	For U-value from calculation or measurement: Test specimen: 1.23 m x 2.18 m ≤ overall area of 3.6m <sup>2</sup> Test specimen: 2.00 m x 2.18 m > overall area of 3.6m <sup>2</sup>
	Radiation properties	All sizes
	Air permeability	Weather stripping on four sides: - 100 % to + 50 % of test specimen overall area Weather stripping on three sides: - 100 % of test specimen overall area
	Operating forces	- 100 % of test specimen overall area
	Mechanical strength	- 100 % of test specimen overall area
	Ventilation	Same design and size of ventilation device
	Bullet resistance	Until relevant standards and/or guidelines are in place, undetermined conditions shall be agreed on by the manufacturer and the testing laboratory..
	Explosion resistance	Until relevant standards and/or guidelines are in place, undetermined conditions shall be agreed on by the manufacturer and the testing laboratory..
	Durability (Resistance to repeated opening and closing)	- 100 % of test specimen overall area
	Behaviour between different climates	Test specimen: 1.23 m x 2.18 m
	Burglar resistance	See ENV 1627